

Moov™

Mobile Computing Station



LIBERATE
YOUR
DESKTOP



Introducing Moov™, the first configurable multi-purpose mobile computing station. Select from a broad range of accessory options to meet your exact requirements. Moov™ can readily accommodate LCD's, laptops, tablet PCs and kiosk/all-in-one computers. Battery-powered and non-powered versions are available.

MOOV

Best of all, Moov™ will adapt with you as your needs change... quickly add or remove components at any time. It's perfect for retail, healthcare, IT... anywhere a mobile computer is required.

FEATURES

- ▲ Completely configurable
- ▲ Easily upgrade or remove accessories
- ▲ Sleek, modern style
- ▲ Available with or without a battery
- ▲ Cable management keeps cords out of view



Optional folding keyboard/
mouse surface



Combine with any
Innovative LCD arm



Cable management keeps
cables organized and
out of view

MOOV™ Component Guide

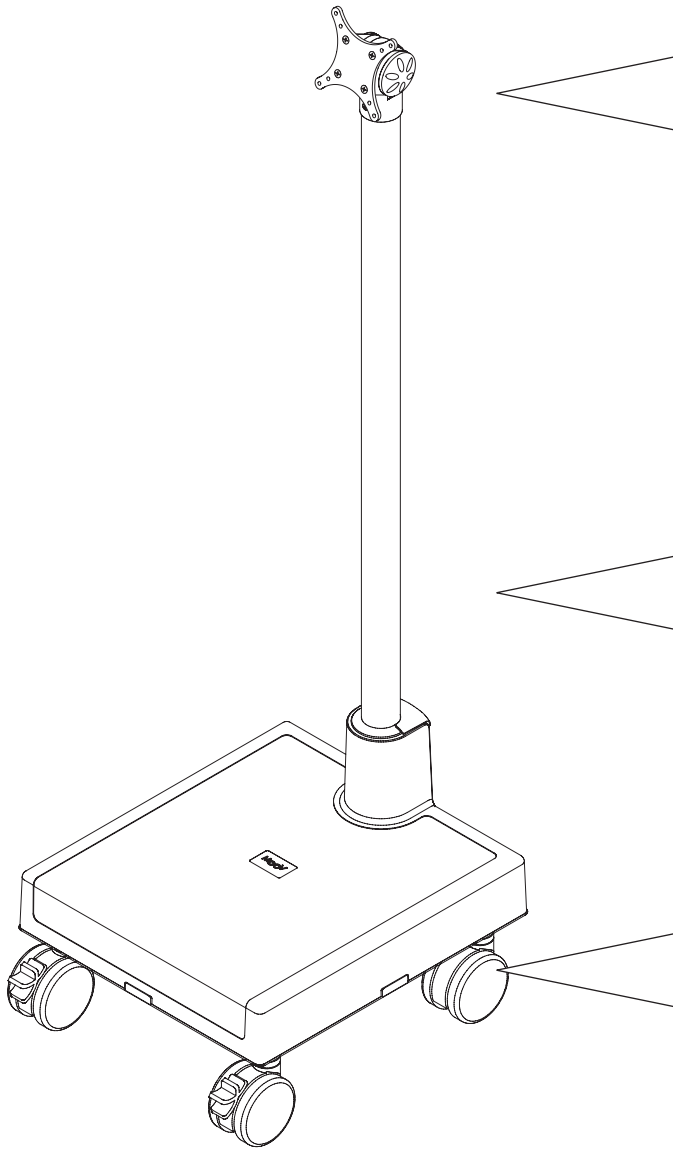

STEP 3: ACCESSORIES

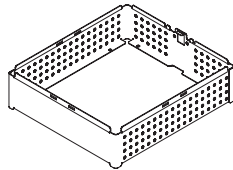

Large Base Riser
Moov-RIS-4.5-104
Inner storage capacity of 7" tall x 17" wide x 16" deep.

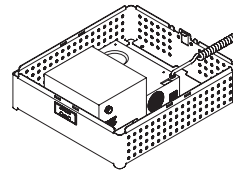

54 Amp/Hour Battery
Moov-BAT-54
54 amp/hour battery, power supply, RUI and large base riser.

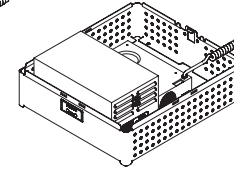

90 Amp/Hour Battery
Moov-BAT-90
90 amp/hour battery, power supply, RUI and large base riser.



Weight Plate
Moov-WGT
Adds 50 lbs of weight to bottom of base to increase stability.

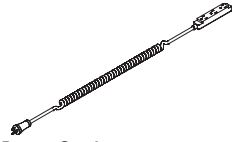

Power Cord
Moov-CORD
Retractable power cord with three receptacles.

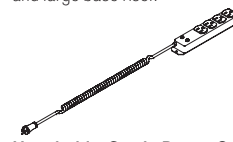

Hospitable-Grade Power Cord
Moov-CORD-H
Retractable hospital-grade power cord with four receptacles.

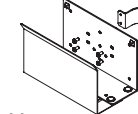

CPU Holder
Moov-SM-CPU (for CPUs 2"-3" wide)
Moov-MD-CPU (for CPUs 3"-5" wide)
Moov-LG-CPU (for CPUs 5"-7.5" wide)
Adjustable CPU holder attaches to pole.

STEP 2: POLE



Moov-P35-ARM
Moov-P55-ARM
Tube with bushing to accept arm shaft. 35" and 55" pole lengths.

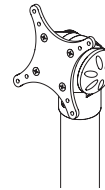

Moov-P35-POS
Moov-P55-POS
Tube with POS tilter and 75/100 VESA adapter. 35" and 55" pole lengths.

STEP 1: BASE

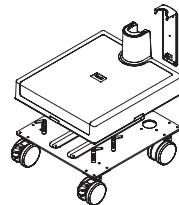

Moov-100-BLK
Moov base kit with wheels, base, cover and non-lock snap. Inner storage capacity of 2.5" tall x 17" wide x 16" deep.

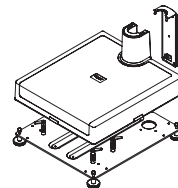

Moov-101-BLK
Moov base kit with pads, base, cover and non-lock snap. Inner storage capacity of 2.5" tall x 17" wide x 16" deep.